

## OPIS TECHNICZNY

### BIURKO

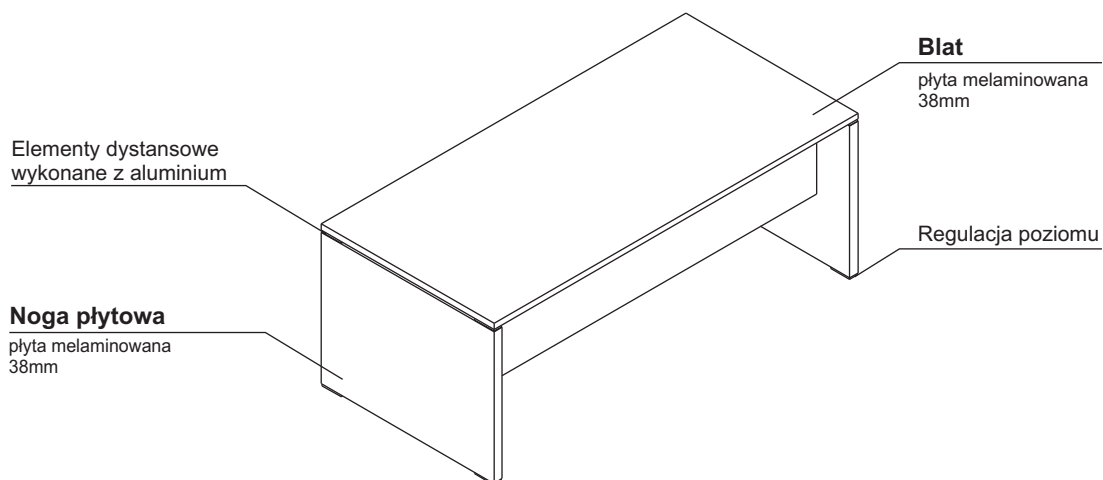

### KOMODA

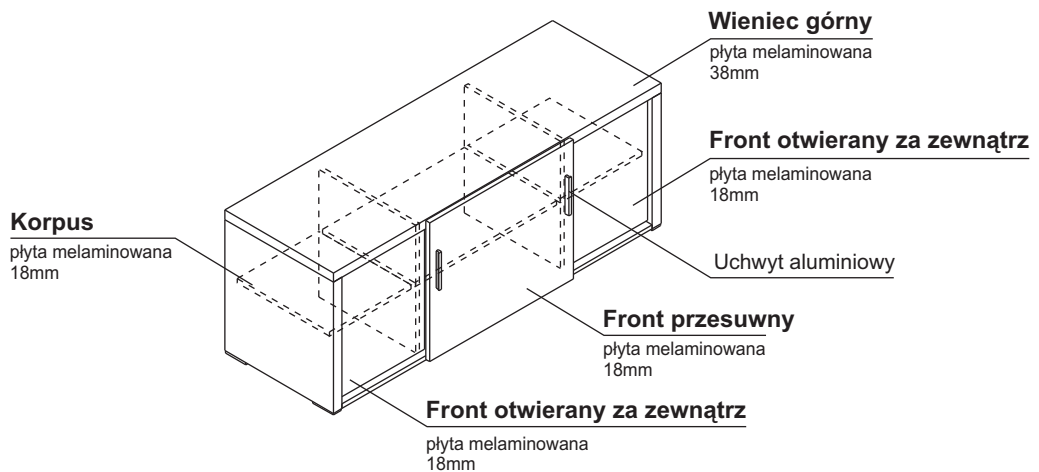

### SZAFA I KONTENER MOBILNY

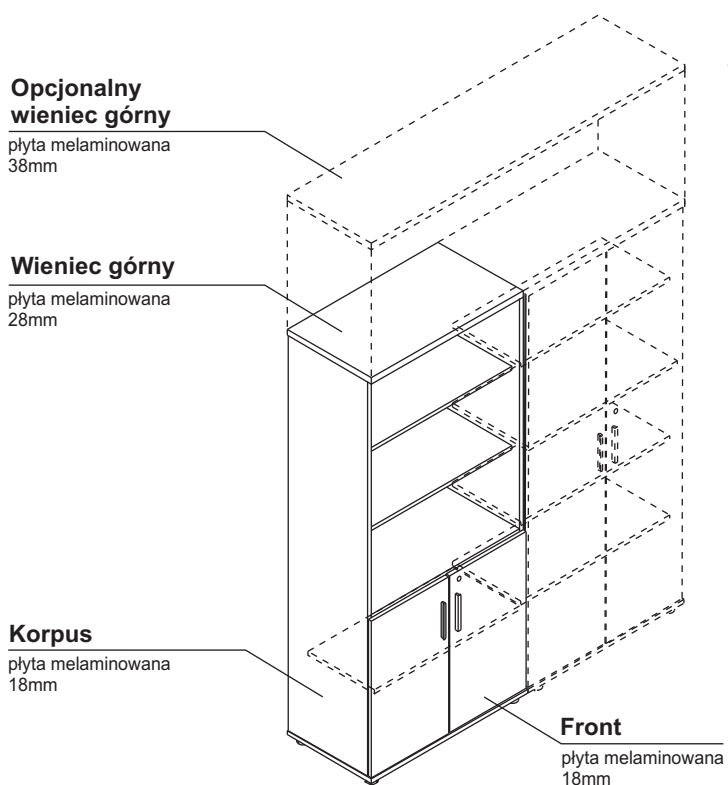

Opcjonalny wieniec górny nakładany na 1, 2 lub 3 zestawione szafy o szerokości 800mm.

Opcjonalny wieniec górny zastępuje standardowy.

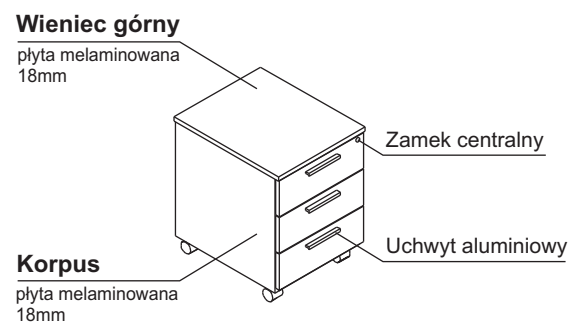

## KOLORYSTYKA

BIURKO

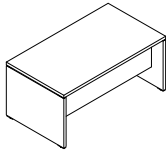

34-KASZTAN  
106-ORZECH NIZINNY

PRZYSTAWKA

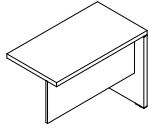

34-KASZTAN  
106-ORZECH NIZINNY

KOMODA

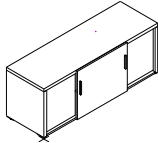

34-KASZTAN  
106-ORZECH NIZINNY

STÓŁ

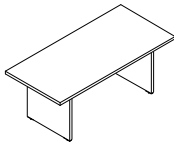

34-KASZTAN  
106-ORZECH NIZINNY

KONTENER



34-KASZTAN  
106-ORZECH NIZINNY

SZAFA

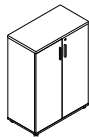

34-KASZTAN  
106-ORZECH NIZINNY

OPCJONALNY  
WIENIEC GÓRNY

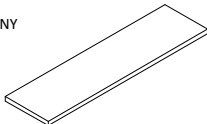

34-KASZTAN  
106-ORZECH NIZINNY

WIDOK I RZUT OBIEKTU	WYMIARY (mm)			SYMBOL	UWAGI
	Szerokość a / a'	Głębokość b / b'	Wysokość h		

## BIURKA, PRZYSTAWKA

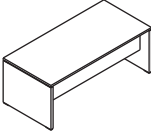
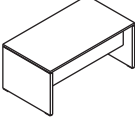
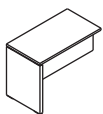
	1900	900	740	<b>Q19</b>	
	1600	900	740	<b>Q16</b>	
	1000	550	740	<b>Q10</b>	- uniwersalne: lewe, prawe

## BIURKO Z SZAFKĄ

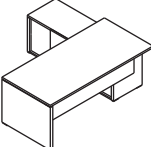
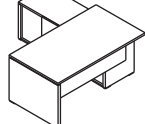
	1900/2164	900/1800	740	<b>QU19</b>	
	1600/1864	900/1800	740	<b>QU16</b>	

## USTAWIENIA

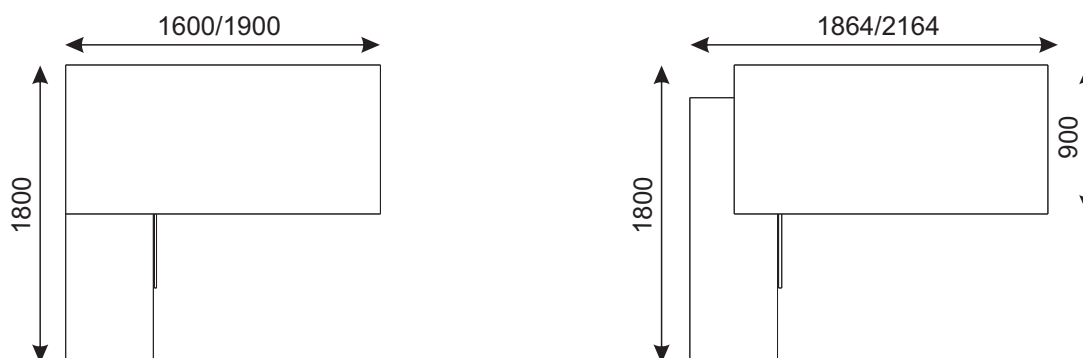

## KOMODA

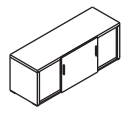
	1600	550	600	<b>QR16</b>	
---	------	-----	-----	-------------	--

## KONTENER

	434	520	580	<b>Q13</b>	
---	-----	-----	-----	------------	--

WIDOK I RZUT OBIEKTU	WYMIARY (mm)			SYMBOL	UWAGI
	Szerokość a / a'	Głębokość b / b'	Wysokość h		

## STOŁY I STOLIKI

	1900	900	740	<b>QS19</b>	
	800	800	550	<b>QSL08</b>	
	800	800	740	<b>QS08</b>	

## SZAFY

	1400	431	1280	<b>Q315</b>	szafa cała w kolorze
	802	432	1833	<b>Q51</b>	
	802	432	1833	<b>Q54</b>	
	802	432	1129	<b>Q31</b>	
	802	432	1129	<b>Q35</b>	
	800	20	1050	<b>KS300</b>	- kpl. drzwi szklanych 3 OH z ramką aluminiową - szkło mleczne

## OPCJONALNE WIEŃCE GÓRNE DO SZAF

	806	432	38	<b>QT08</b>	
	1608	432	38	<b>QT16</b>	
	2410	432	38	<b>QT24</b>	